

Brunswick
ANNIVERSARY BILLIARD TABLE

THE J.M. BRUNSWICK & BALKE COMPANY
BILLIARD TABLE



**CELEBRATING 180 YEARS
OF BILLIARDS EXCELLENCE**

2025 | PRODUCT CATALOG

Brunswick Billiard Hall
AND RESTAURANT
BRUNSWICK & KERN, Proprietors,
Washington Street,
Chicago, Illinois.
J. M. BRUNSWICK & BALKE
CHARLES KERN
SINCE 1877

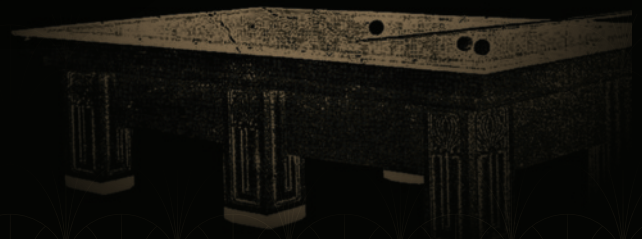

180 YEAR HISTORY OF BILLIARD

1845

Founded by
John Moses
Brunswick



Moved Offices
to Bristol,
Wisconsin

1908

Established
Official Chicago
Headquarters



1986

The Original
Air Hockey
First Invented by
Brunswick Billiards

1969

1945

Celebrating
100 Years of
Service



History is made with the introduction of Gold Crown Billiard Tables 1961

EXCELLENCE 



 2011

*50 Year Anniversary of
the Gold Crown Series*

ESCALADE
SPORTS

2022 

*Acquired by
Escalade
Sports*

2025 



*Celebrating 180 Years of
Craftsmanship & Innovation*



BRUNSWICK

**THE MOST PRESTIGIOUS
NAME IN BILLIARDS**

In 1845, John Moses Brunswick set out to build the world's most trusted brand in billiard tables. Applying his formidable craftsmanship, a mind for innovation, and a passion for the game, he created a company synonymous with quality and billiard excellence.

Since then, Brunswick has evolved the sport of billiards and set lasting standards for years to come. We continue the tradition of creating tables that are not only engineered for premium performance, but are designed to be works of art.

Brunswick Billiards tables have been the choice of presidents, sports stars, celebrities, and industry leaders. A Brunswick table creates a natural place to gather, laugh, enjoy the company of others, and make strong, lasting connections.

TABLE OF CONTENTS

5

BILLIARD TABLES

- | | | |
|--|---|--|
| 6 Billiard Table Construction | 18 Parsons Billiard Table | 28 Brae Loch Billiard Table |
| 8 Gold Crown VII Billiard Table | 19 Matanza Billiard Table | 29 Oakland II Billiard Table |
| 10 Gold Crown VI Billiard Table | 20 Dameron Billiard Table | 30 Santini Billiard Table |
| 12 Gold Crown Coin Billiard Table | 21 The Henderson Billiard Table | 31 Black Wolf II Billiard Table |
| 13 Birmingham Billiard Table | 22 Canton Billiard Table | 32 Botanic Billiard Table |
| 14 Centennial Billiard Table | 23 Soho Billiard Table | 33 Hickory Billiard Table |
| 15 Brescia Billiard Table | 24 Sanibel Billiard Table | 34 Winfield Billiard Table |
| 16 Sagrada Billiard Table | 25 Black Wolf Pro Billiard Table | 35 Allenton Billiard Table |
| 17 The Bali Billiard Table | 26 Glenwood Billiard Table | 36 Billiard Cloth |

38

RECREATIONAL GAME TABLES & GOLF

- | | | |
|------------------------|-------------------------------------|-----------------------------|
| 38 Shuffleboard | 52 Conversion Tops and Caddy | 57 Air Hockey Tables |
| 49 Table Tennis | 53 Foosball Tables | 60 Putting Greens |

65

FURNITURE

- | | | |
|---------------------------------|-------------------------------------|---------------------------------|
| 66 Parsons Collection | 69 Traditional Collection | 71 Furniture Collections |
| 67 Centennial Collection | 70 Brunswick Arena Furniture | |

72

CUE RACKS, CUES AND ACCESSORIES

- | | | |
|------------------------------|--------------------------|---------------------------------|
| 73 Billiard Cue Racks | 79 Play Packages | 82 Billiard Table Covers |
| 76 Billiard Cues | 80 Billiard Balls | 83 Billiard Accessories |

BRUNSWICK BILLIARD TABLES

Today's Brunswick Billiards tables are masterpieces of craftsmanship, design, and innovation, continuing the legacy of excellence begun almost two centuries ago.



THE GAME CHANGERS

Brunswick's legacy is derived from building the best. If you look inside a Brunswick table, this becomes clear as you see innovation after innovation. Every extra step we take in the building process ensures we achieve superior accuracy and consistency in our tables. We are proud to stand behind the quality, materials and workmanship of every product that carries the Brunswick name.

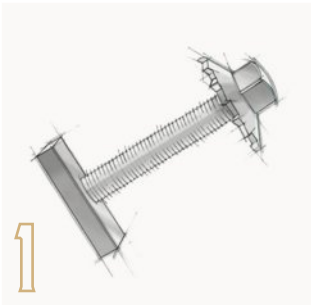

OUR HIGH PERFORMANCE™ NUT PLATES

Our exclusive nut plates allow for the application of 70% more torque to each connection, ensuring a solid, seamless transition between rail and slate that enhances performance and playability.

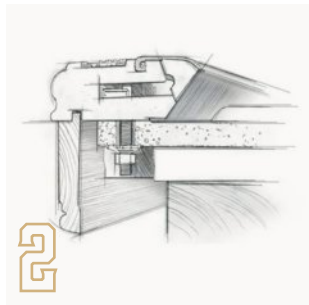

HARDENED DOME WASHER

To maintain the integrity of the rail-to-slate connection long term, a hardened domed washer is utilized which provides constant tension between the rail and the slate, and prevents twisting or loosening over time.



SUPERSPEED® CUSHION RUBBER

Brunswick SuperSpeed cushions have set the standard for over 90 years with a proprietary rubber formulation and shape. We start with 100% gum rubber, add a synthetic rubber that is derived from a formula created by B. F. Goodrich Co. in the 1930's, mix in the requisite bonding materials and then extrude a high grade cushion rubber that provides accuracy, control and rail consistency.

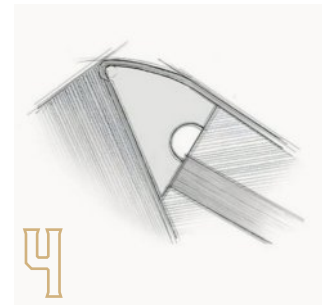

HIGH PRESSURE BONDING

Precision is critical and cushion rubber bonding and placement are essential to the overall performance. Brunswick achieves superior accuracy and consistency through proprietary pneumatically controlled machines that bond the cushion rubber to the rails for a precision fit that doesn't vary.

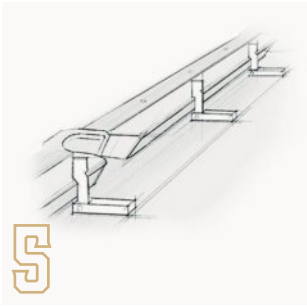

ACCURATE NOSE HEIGHT

Banking and rebound accuracy rely on the nose height of the table's cushion rubber. Brunswick's automated, pneumatically controlled machines precisely place the cushion rubber ensuring consistent nose height all around the table that meets the 64% of a 2.25" diameter ball standard.



SOLID HARDWOOD RAILS

Brunswick rails are made of solid hardwood. The rails are machined to exacting standards and provide a solid foundation behind the cushion rubber to ensure exceptional accuracy and performance.

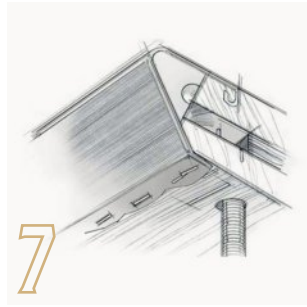

MACHINE RECESSED AREA

A machined recess groove is cut into the rail to allow the rail cloth to be securely stapled many times over and not interfere with the rail attachment to the slate while ensuring the nose height of the cushion is not affected no matter the thickness of the cloth.



STATE-OF-THE-ART FINISHING

Brunswick uses the best materials possible and undergoes the most demanding and time-consuming process to achieve the optimal billiard table finish. From working with world class furniture finish suppliers to conducting a 12-step or more finishing process, Brunswick cuts no corners. The evidence is in the end results... Go Ahead and Feel It!

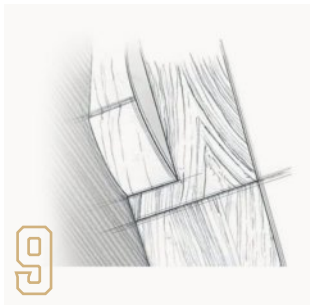

STABLE JOINERY CONSTRUCTION

Brunswick uses fine furniture joinery techniques in the construction of all solid hardwood products. These joinery techniques such as panels glued together with alternating grain patterns, create a stronger, more stable furniture construction that will provide flawless performance year after year.

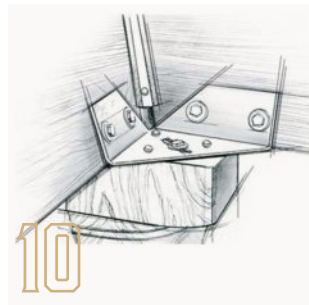

ROCK-SOLID AND READY TO INSTALL

Brunswick tables come ready to assemble. We utilize machine nut and bolt construction techniques to achieve a rock solid fine furniture product that is easy to assemble anywhere – in a home, business or recreation center.

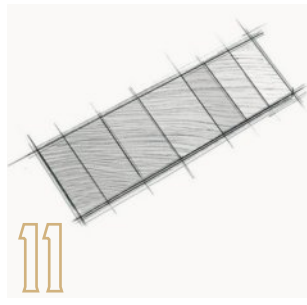

KILN-DRIED, STAINED, AND SEALED

Brunswick tables are built to last for generations. All solid wood materials are kiln-dried to a 6-8% moisture level, then stained and sealed to keep moisture out. A durable furniture finish completes the look of each product.



BRUNSWICK CERTIFIED SLATE

Brunswick slate must pass rigid quality requirements before it receives a "Brunswick Certified" sticker. Brunswick slate is diamond-honed, precision-machined and leveled to within 10/1000th of an inch which is 3X the Billiard Congress of America standard of 30/1000th. Brunswick slate is cured for an extended period of time to assure stability and is checked for flatness on the top and bottom at least four times through the machining and curing process. Every set of Brunswick slate is quality inspected and certified to provide a lifetime of playability.



NEW!
GOLD CROWN VII

“BEST PLAYING & MOST ACCURATE PLAYING TABLE ON THE MARKET”

Gold Crown VII continues the legacy that began in 1961 with the legendary Gold Crown I. This reimagined classic blends the familiar elegance of historic Gold Crown designs with today's cutting-edge technology, creating the ultimate play table for the commercial environment.

Every detail has been meticulously considered, from the iconic decorative apron trim that pays homage to the original Gold Crown I to the innovative features designed to simplify installation, service, and maintenance.



Tournament Black

FEATURES

- Innovative One Pocket Stadium Ball Storage Option Available*
- Finish Options: Tournament Black, Classic Brown, or Modern White
- Zinc Die-Cast Brunswick Pocket & Corner Castings (Gunmetal/Brushed Nickel)
- Rail Sights (White/Black)
- Iconic Decorative Corner Apron Trim
- Gold Crown Resin Bridge Holder
- Adjustable Foot Levelers
- Available Sizes: 8' & 9'



Modern White



Classic Brown
Brunswick logos not included on
8ft table aprons

Size	8' or 9'
Dimensions (L x W)	102.6" x 58.8" / 114.6" x 64.8"
Weight	1,030 lbs* / 1,221 lbs*
Pocket Options	One Pocket Stadium Ball Storage
Legs	Standard
Slate	1" Framed
Cloth Color	15 options
Finish Options	Tournament Black, Classic Brown, or Modern White

POCKET SIZES

- 8' (4 ¾" / 5 ¼")
- 9' (4 ¾" / 5 ¼"), (4 ½" / 5"), (4 ¼" / 4 ¾"), (4" / 4 ½")

*Patent pending



*Patent pending optional one pocket stadium ball storage



GOLD CROWN VI

The Gold Crown VI continues Brunswick's tradition of excellence as the newest edition of the legendary table series. The Gold Crown VI features a familiar design with modern styling. The new, low-profile leg base and hidden stretcher provide a streamlined appearance while the angular canted leg emphasizes the clean lines. The table also features all new rail castings in a brushed nickel finish for a sleek, high-end aesthetic.



Skyline Walnut/Espresso Finish
9' model shown: ball storage
box not included on 8' model

FEATURES

- High Performance™ Nut Plate Construction
- SuperSpeed® Cushion Rubber
- Brunswick Certified Premium Slate
- Coordinating Commercial Cue Rack in Black sold separately



Matte Black Finish
with Gully Option



Mahogany Finish
(Tournament Edition)



Skyline Walnut/Espresso Finish
8' model shown

Size	8' or 9'
Dimensions (L x W)	102.6" x 58.8" / 114.6" x 64.8"
Weight	1,030 lbs* / 1,221 lbs*
Pocket Options	Drop Pocket or Gully
Legs	Standard
Slate	1" Framed
Cloth Color	15 options

Finish Options
Mahogany with Nickel Trim, Matte Black with Nickel Trim, Skyline Walnut/Espresso with Nickel Trim, Tournament Edition - Mahogany, Matte Black or Skyline Walnut/Espresso, each with Nickel Trim (9' only all finishes)

TOURNAMENT EDITION

The Gold Crown VI Tournament Edition table features tighter pockets engineered to strict World Pool-Billiard Association specifications. Table decals included.

* Shipping weight



GOLD CROWN COIN

The Gold Crown Coin combines the Brunswick Gold Crown VI playability with PAT (Pay at Table) technology. Designed for years of profit for the room owner and to please the most discerning player at the same time.



No pay, on request



With Coin Chute only



With Coin Chute and Bill Acceptor

FEATURES

- High Performance™ Nut Plate Construction
- SuperSpeed® Cushion Rubber
- Brunswick Certified Premium 1" Slate
- Pay at Table Options:
 - Coin chute only
 - Coin chute and bill acceptor with programmable electronics
 - Bill acceptor with programmable electronics only (see detail pic)
 - PatRange available on request
 - No Pay on request

Size	7'
Dimensions	89.3" x 51.3"
Weight	1,085 lbs*
Pockets	Gully return only
Legs	Unique, Standard
Slate	1" Unframed, One Piece
Cloth Color	Tour Edition Championship Blue
Finish	Matte Black with Black Trim / Nickel Castings and Corners

** Shipping weight*



BIRMINGHAM

Combining rugged charm with an industrial, loft-style look makes the Birmingham a perfect choice for modern game rooms in need of a vintage touch. Featuring a distressed, rough-hewn finish with a cast iron decorative pedestal and turnbuckle stretcher element, the Birmingham is stylish and rustic down to the last detail.



FEATURES

- Brunswick Certified Premium Slate
- SuperSpeed® Cushion Rubber
- Hand-hammered Rail Sights
- High Performance™ Nut Plate Construction
- Rough-hewn Finish with Distressing
- Cast Iron Pedestal Base, Decorative Rail Spacer, and Turnbuckle Stretcher Element
- Coordinating Wall Rack Sold Separately

Size	8' or 9'
Dimensions	102" x 58" / 114" x 64"
Weight	1,123 lbs* / 1,361 lbs*
Pockets	Drop Pocket
Legs	Cast Iron
Slate	1" Framed
Cloth Color	15 options
Finish	Charcoal

* Shipping weight



CENTENNIAL

An iconic table from the 1940's & 50's, the Centennial has been reborn with material refinement allowing the antique design to be combined with technological improvements to deliver both commercial grade performance and an outstanding home design. This table will be sought after by collectors as well as the discerning designer for use in multi-functional environments.



(Top: Shown with ball storage box. Bottom: Shown with ball storage box and receiver box (gully option)

FEATURES

- Brunswick Certified Premium 1" Slate
- SuperSpeed® Cushion Rubber
- High Performance™ Nut Plate Construction
- Ball Storage Foot End
- Drop Pocket or Gully Options

Size	8' or 9'
Dimensions	101" x 57" / 113" x 63"
Weight	901 lbs / 1,129 lbs*
Pockets	Drop Pocket or Gully
Legs	Unique, Standard
Slate	1"
Cloth Color	15 options
Finish	Rosewood with Polished Aluminum



BRESCIA

Explore the allure of the Brescia 8' Billiard Table, inspired by the artisanal elegance of its namesake city in Italy. Its captivating design features a base reminiscent of the harmonious strings of a harp, crafted from cylindrical metal uprights with a luxurious champagne bronze finish. Complemented by angled aprons in a rich, dark charcoal, this table combines beauty with functionality, featuring polished stainless steel rail sights and low-profile drop pockets seamlessly integrated into its sleek design.



FEATURES

- Brunswick Certified Premium 1" Slate
- High Performance™ Nut Plate Construction
- SuperSpeed® Cushion Rubber
- Bronze Powder Coated Steel Pedestal Tubing/Plate
- Polished Stainless Steel Rail Sights

Size	8'
Dimensions	103.8" x 59.8"
Weight	1020 lbs*
Pockets	Low Profile Drop Pocket
Legs	Steel / White Oak
Slate	1" Framed
Cloth Color	14 options
Finish	Dark Charcoal

* Shipping weight



SAGRADA

The Sagrada billiard table is a game room statement piece like no other. Its unique Sandwashed finish and mother-of-pearl sights make it both visually stunning and great for playability. Its broad table legs provide extra stability, and its Spanish name 'Sagrada', meaning 'sacred', exemplifies its distinguished craftsmanship.



FEATURES

- Brunswick Certified Premium 1" Slate
- SuperSpeed® Cushion Rubber
- Mother of Pearl Sights
- High Performance™ Nut Plate Construction
- Coordinating Wall Rack Sold Separately

Size	8'
Dimensions	102" x 58"
Weight	850 lbs*
Pockets	Drop Pocket Standard
Legs	Unique, Standard
Slate	1"
Cloth Color	14 options
Finish	Sandwashed



THE BALI

Complete your outdoor oasis with The Bali. This indoor/outdoor pool table is designed to weather the elements while maintaining exceptional playability synonymous with Brunswick Billiards. This stylish billiard table features a stainless-steel base, wicker aprons and teak rails. Engineered to last for generations, every detail has been meticulously considered to enjoy for years to come.



FEATURES

- Brunswick Certified Premium 1" Unframed Slate
- SuperSpeed® Cushion Rubber
- Brushed Stainless Steel Sights
- High Performance™ Nut Plate Construction



Size	8'
Dimensions	100" x 58"
Weight	900 lbs*
Pockets	Drop Pocket
Legs	Unique, Standard
Slate	1" Unframed
Cloth Color	4 options
Finish	Weathered Grey

* Shipping weight



PARSONS

The Parsons billiard table features a sturdy, minimalist design with a natural dry oak finish, showcasing the timeless beauty of natural wood knots and cracks. Crafted clean lines and a touch of rustic charm, it offers a warm and inviting atmosphere for any space.



FEATURES

- Brunswick Certified Premium 1" Slate
- SuperSpeed® Cushion Rubber
- High Performance™ Nut Plate Construction
- Natural Wood Knots & Cracks
- Coordinating Wall Rack Sold Separately



Size	8'
Dimensions	105" x 61"
Weight	930 lbs*
Pockets	Low Profile Drop Pocket
Legs	Unique, Standard
Slate	1"
Cloth Color	14 options
Finish	Natural Dry Oak



MATANZA

Matanza is a uniquely designed table that will endure for generations. Every attribute from the pedestal design to the finish was created with pride. Incorporate this beautiful piece to enhance the aesthetics of any room it occupies.

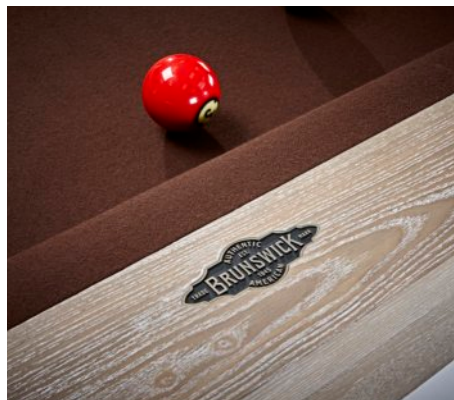

FEATURES

- Brunswick Certified Premium 1" Slate
- SuperSpeed® Cushion Rubber
- Matching Finish Metal Sights
- High Performance™ Nut Plate Construction
- Coordinating Wall Rack Sold Separately



Size	8'
Dimensions	100.5" x 56.5"
Weight	900 lbs*
Pockets	Low Profile Drop Pocket
Legs	Unique, Standard
Slate	1" Framed
Cloth Color	14 options
Finish	Sandwashed

* Shipping weight



DAMERON

Mixing solid hardwood, white oak veneer and employing steel legs, the durability and elegance of Dameron makes for a decadent piece that can accommodate any recreation space. Every attention to detail was given from the hand-hammered metal sights to the Brunswick name plate in the leg pedestal. Made to endure with beauty & grace.



FEATURES

- Brunswick Certified Premium 1" Slate
- SuperSpeed® Cushion Rubber
- Hand-Hammered Metal Sights
- High Performance™ Nut Plate Construction
- Coordinating Wall Rack Sold Separately

Size	8'
Dimensions	101.5" x 56.5"
Weight	1,150 lbs*
Pockets	Drop Pocket Indoor/ Outdoor Standard
Legs	Unique, Standard
Slate	1" Framed
Cloth Color	14 options
Finish	Nutmeg



THE HENDERSON

The Henderson offers the sleek look of a fine dining room table with the legendary playability of the Brunswick Billiards brand. A beautiful table in its own right, The Henderson offers the versatility to quickly change your game room to fit your needs, simply use the optional dining top and transform your game room into a banquet room, a conference room, an arts & crafts room or leave it off and enjoy hours of play on this elegant model.



FEATURES

- Polished Stainless-Steel Sights
- Brunswick Certified Premium 1" Slate
- SuperSpeed® Cushion Rubber
- High Performance™ Nut Plate Construction
- Coordinating Wall Rack Sold Separately*

* Matte Black/Walnut cue rack is sold out and no longer available.

Size	8'
Dimensions	103.1" x 59.1"
Weight	880 lbs*
Pockets	Low Profile Drop Pocket
Legs	Unique, Standard
Slate	1" Framed
Cloth Color	14 options
Finish	Espresso or Aged Linen/ Walnut

* Shipping weight



CANTON

Nothing says “rack ‘em up” like the rustic-meets-industrial charm of our Canton billiard table. With its artful hand-hammered sights and aged metal turnbuckle stretchers, corners, and hardware, this eight-foot table is the perfect marriage of proud craftsmanship and industrial design.



FEATURES

- Brunswick Certified Premium 1" Slate
- High Performance™ Nut Plate Construction
- SuperSpeed® Cushion Rubber
- Aged Metal Turnbuckle Stretchers, Corners, and Hardware
- Hand-Hammered Sights
- Coordinating Wall Rack Sold Separately

Size	7' or 8'
Dimensions (L x W)	90" x 52" / 102.1" x 58.1"
Weight	638 lbs / 769 lbs*
Pockets	Low Profile Drop Pocket
Legs	Unique
Slate	1" Framed
Cloth Color	14 options
Finish Options	Black Forest, Rustic Grey (8' only)

* Shipping weight



SOHO

The Soho features ultra clean, minimalist lines and a modern design. Specialized hand hammered sights provide unique detailing and the new low-profile pockets keep the table incredibly sleek. The Soho is available in Nutmeg. Complete your Soho billiard table with the Nutmeg Dining Top, sold separately.

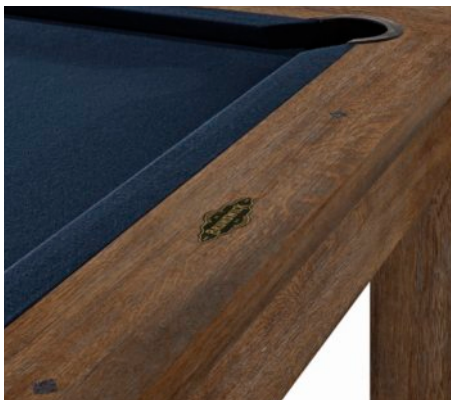

FEATURES

- Brunswick Certified Premium 1" Slate
- High Performance™ Nut Plate Construction
- Brunswick Cushion Rubber
- Solid Hardwood Construction
- Hand Hammered Rail Sights

Size	8'
Dimensions	102" x 58"
Weight	850 lbs*
Pockets	Low Profile Drop Pocket
Legs	Unique, Standard
Slate	1" Framed
Cloth Color	14 options
Finish	Nutmeg

* Shipping weight



SANIBEL

The Sanibel features a modern design with ultra clean lines and minimalist aesthetic. Specialized hand hammered sights provide unique detailing and the new low-profile pockets keep the table incredibly sleek. The Sanibel is available in 7' and 8' sizes in both Rustic Grey and Rustic Dark Brown finishes. Complete your Sanibel billiard table with a Dining Top and the Sanibel Wall cue rack, each sold separately.



FEATURES

- Brunswick Certified Premium 1" Slate
- High Performance™ Nut Plate Construction
- SuperSpeed® Cushion Rubber
- Solid Hardwood Construction
- Hand Hammered Rail Sights
- Coordinating Wall Rack Sold Separately

Size	7' or 8'
Dimensions	90" x 52" / 102" x 58"
Weight	709 lbs / 880 lbs*
Pockets	Low Profile Drop Pocket
Legs	Unique, Standard
Slate	1"
Cloth Color	14 options
Finish	Rustic Dark Brown, Rustic Grey

* Shipping weight



BLACK WOLF PRO

The Black Wolf Pro, a superb combination of modern styling and rigorous engineering standards, features attractive and sturdy pedestal-style legs, a leg stretcher, foot levelers, and gully return is an available option. Our Commercial Wall Rack is also available to beautifully match the Black Wolf Pro table.



** Decal sold separately*

FEATURES

- Brunswick Certified Premium 1" Slate
- High Performance™ Nut Plate Construction
- SuperSpeed® Cushion Rubber
- Round Rail Sights
- Optional Gully Return

Size	7', 8' or 9'
Dimensions	89.25" x 51.25"
	101.25" x 57.25"
	113.25" x 63.25"
Weight	605 lbs* / 797 lbs* / 989 lbs*
Pockets	Drop Pocket or Gully
Legs	Pedestal
Slate	1" Framed
Cloth Color	15 options
Finish	Matte Black

** Shipping weight*



GLENWOOD

A traditional table with modern sensibilities, the Glenwood is a graceful addition to any home. Plus, have it your own way with Brunswick's most versatile model. This customizable table offers a wide variety of table finishes, leg styles, cloth, and pocket styles. Design the perfect solid wood table for your home at an affordable price.

FEATURES

- High Performance™ Nut Plate Construction
- Brunswick Certified Premium 1" Slate
- SuperSpeed® Cushion Rubber
- Pearlized Rail Sights
- Base Frame Dovetails

Size	7', 8' or 9'
Dimensions (L x W)	86.5" x 48.5"
	98.5" x 54.5"
	110.5" x 60.5"
Weight	589 lbs* / 695 lbs* / 892 lbs*
Pockets	Leather Shield Drop Pocket
Leg Options	Ball and Claw, Tapered, Talon
Slate	1" Framed
Cloth Color	15 options
Finish Options	Espresso, Matte Black/Coffee, Coffee, Rustic Grey, Tuscana

* Shipping weight

POCKET



Leather Shield

LEG OPTIONS



Ball and Claw



Tapered



Talon

	ESPRESSO			MATTE BLACK/COFFEE			COFFEE			RUSTIC GRAY			TUSCANA		
	7'	8'	9'	7'	8'	9'	7'	8'	9'	7'	8'	9'	7'	8'	9'
Ball and Claw	•	•	•											•	
Tapered	•	•	•	•	•		•	•			•			•	
Talon	•	•	•	•	•										



Espresso / Espresso Pockets
with Ball and Claw Leg



Matte Black & Coffee / Black
Pockets with Talon Legs



Coffee / Black Pockets
with Tapered Legs



Tuscana / Espresso Pockets
with Tapered Legs



Rustic Gray / Black Pockets
with Tapered Legs



BRAE LOCH

This traditionally- styled and beautifully made Brunswick Brae Loch 8ft billiard table makes a classic centerpiece for any game or family room. Traditionally styled in a nutmeg finish, the Brae Loch billiard table features a double-arched base with ball-and-claw legs. Durable, classic design crafted to last, the Brae Loch frame is constructed of superior engineered and select veneered hardwood. Classic in style, this table has Brunswick slate accents and camphor burl inlays with a double arch. Shield style pockets for a traditional look.



FEATURES

- Brunswick Certified Premium 1" Slate
- Brunswick Cushion Rubber
- Pearlized Plastic Rail Sights
- High Performance™ Nut Plate Construction
- Nutmeg Finish

Size	8'
Dimensions	98.5" x 54.5"
Weight	697 lbs*
Pockets	Leather Shield Drop Pocket
Legs	Standard Ball and Claw
Slate	1" Framed
Cloth Color	14 options
Finish	Nutmeg

* Shipping weight



OAKLAND II

The straight lines, simple design, and heavy proportion of the Oakland II table are trademark characteristics of the Arts & Crafts style of furniture originally popular during the 1890s to 1910s. This distinct table features solid wood rails, leather shield pockets, and comes in beautiful espresso and rustic grey finishes.



Rustic Grey with Black Pocket

FEATURES

- Brunswick Certified Premium 1" Slate
- High Performance™ Nut Plate Construction
- Brunswick Cushion Rubber
- Diamond-Shaped White Pearlized Rail Sights
- Available Accessories:
 - Dining Top
 - Heritage Wall Cue Rack (Espresso only)
 - Heritage Floor Cue Rack (Rustic Grey only)
 - Table Tennis Conversion Top



Rustic Grey finish with Black Pocket

Size	8'
Dimensions (L x W)	98.5" x 54.5"
Weight	794 lbs*
Pockets	Leather Shield Drop Pocket
Legs	Unique
Slate	1" Framed
Cloth Color	14 options
Finish Options	Espresso, Rustic Grey

* Shipping weight



SANTINI

With ornate post legs, and a veneer inlay pattern with an edge molding on the sills, the Santini, with a rich espresso finish, will make a great addition to any home.



FEATURES

- Brunswick Certified Premium 1" Slate
- High Performance™ Nut Plate Construction
- Brunswick Cushion Rubber
- Burled Inlay on sills
- Pearlized Plastic Rail Sights

Size	8'
Dimensions	98.5" x 54.5"
Weight	745 lbs*
Pockets	PVC Shield Drop Pocket
Legs	Unique, Standard
Slate	1" Framed
Cloth Color	14 options
Finish	Espresso

* Shipping weight



BLACK WOLF II

Naturally dramatic, the Black Wolf table is in its element in contemporary homes, from casually chic to sleek and sophisticated. Durable metal rail pocket corners, round rail sights, and jet-black laminate provide the perfect detail. Built for a lifetime of enjoyment.



FEATURES

- Brunswick Certified Premium 1" Slate
- High Performance™ Nut Plate Construction
- Brunswick Cushion Rubber
- Round Rail Sights
- Leg Levelers

Size	7' or 8'
Dimensions (L x W)	89" x 51" / 101" x 57"
Weight	621 lbs* / 728 lbs*
Pocket Options	Drop Pocket
Legs	Pedestal with Leg Levelers
Slate	1" Framed
Cloth Color	14 options
Finish	Black

* Shipping weight



BOTANIC

Inspired by today's demand for rustic design & finish with a contemporary flare, the Botanic delivers styling combined with the legendary specifications of Brunswick branded billiard tables. Rugged good looks with outstanding playability make the Botanic a must have for the modern but rustic game room.



FEATURES

- Brunswick Certified Premium 1" Slate
- Brunswick Cushion Rubber
- Hand-hammered Metal Sights
- High Performance™ Nut Plate Construction
- Rustic Dark Brown Finish

Size	7' or 8'
Dimensions	88.5" x 50.5" / 102.5" x 56.5"
Weight	624 lbs* / 769 lbs*
Pockets	Low Profile Drop Pocket
Legs	Unique, as shown
Slate	1" Framed
Cloth Color	14 options
Finish	Rustic Dark Brown, Dark Charcoal

* Shipping weight



HICKORY

The Hickory is our spin on a contemporary design combined with a Natural Hickory finish. Uniquely stunning, the Hickory will draw people to pick up a cue and play a game. Built to create everlasting memories.



FEATURES

- Brunswick Certified Premium 1" Slate
- Brunswick Cushion Rubber
- Hand-hammered Metal Sights
- High Performance™ Nut Plate Construction
- Natural Hickory Finish



Size	8'
Dimensions (L x W)	102" x 58"
Weight	850 lbs*
Pocket Options	Low Profile Drop Pocket
Legs	Standard, as shown
Slate	1" Framed
Cloth Color	14 options
Finish	Natural Hickory**

* Shipping weight

** Due to the fact the wood is a natural material, variations in both texture and grain can occur; therefore, item as pictured can vary from the delivered product.



WINFIELD

A sleek, contemporary feel combined with old world charm best describes Winfield. A table that features internal drop pockets, an arched sill and a rich finish, the Winfield is a pleasing fit to any game room. The Winfield is available in either a espresso or coffee finish.



Espresso Finish



Espresso Finish

FEATURES

- Brunswick Certified Premium 1" Slate
- High Performance™ Nut Plate Construction
- Brunswick Cushion Rubber
- Hand-Hammered Metal Sights

Size	8'
Dimensions	100.5" x 56.5"
Weight	746 lbs*
Pockets	Low Profile Drop Pocket
Legs	Unique, Standard
Slate	1" Framed
Cloth Color	14 options
Finish	Espresso, Coffee

* Shipping weight



ALLENTON

A great addition to any home, the Allenton features solid wood rails, Brunswick-Certified Premium Slate, and pearlized diamond-shaped sights to enhance your playing experience. Select the clean, strong lines of the veneered tapered legs in rustic dark brown, espresso, tuscana, or driftwood finish, or opt for the solid wood ball and claw leg in espresso.



Driftwood / Black Pockets with Tapered Legs

FEATURES

- High Performance™ Nut Plate Construction
- Brunswick Certified Premium 1" Slate
- Diamond-Shaped White Pearlized Rail Sights
- Brunswick Cushion Rubber

* Shipping weight



Espresso / Espresso Pockets with Ball and Claw Legs

Size	7' or 8'
Dimensions (L x W)	86.6" x 48.6" / 98.6" x 54.6"
Weight	598 lbs* / 686 lbs*
Pockets	Leather Shield Drop Pocket
Leg Options	Ball & Claw (espresso only), Tapered
Slate	1" Finished
Cloth Color	14 options
Finish Options	Rustic Dark Brown Tapered Leg, Espresso Ball & Claw or Tapered Leg, Driftwood Tapered Leg, Tuscana Tapered Leg

BILLIARD CLOTH

Brunswick Billiards wool cloth is fashioned to the same strict standards as the tables they lay on. Attention to detail and proprietary techniques ensure they stay uniformly resilient and aesthetically pleasing at the same time.



CENTENNIAL® CLOTH

- 100% luxurious Merino wool weave billiard cloth available in 15 colors to reflect your room's individual style.
- Centennial cloth does not pill or shed, maintaining a clean, sleek playing surface.
- Teflon® fabric protector* is incorporated into the cloth fibers, safeguarding the cloth and table from occasional spills and protecting your investment without affecting play.
- Heavier Centennial cloth requires less frequent recovering of the table.

TRADITIONAL CLOTH

- Woolen billiard cloth available in 15 colors to reflect your room's individual style.
- A 2,500 lb. cylinder steams and presses the cloth to give it a harder finish ensuring little or no pilling and faster play.
- All of the wool is bleached before dyeing to provide a cleaner and more vibrant colored product.
- Exclusive shearing process provides the smoothest playing surface possible.



Brunswick Green



Timberline



Olive



Sahara



Chocolate Brown



Merlot



McIntosh



Cardinal Red



Midnight Blue



Regatta Blue



Oceanside



Gun Metal Grey



Charcoal Grey



Ebony



Championship Blue
(Centennial only)

* Teflon® is a registered trademark of Chemours used under license by Brunswick Billiard.

BILLIARD TABLE ROOM SIZE CHART

MINIMUM SPACE REQUIREMENTS

Use the chart to determine the room size needed for a particular pool table and cue combination.

Seven-foot table: 3' 6" x 7' (Playing area: 38" x 76") | 13' (A) x 16' (B)

Eight-foot table: 4' x 8' (Playing area: 44" x 88") | 13' 6" (A) x 17' (B)

Nine-foot table: 4' 6" x 9' (Playing area: 50" x 100") | 14' (A) x 18' (B)

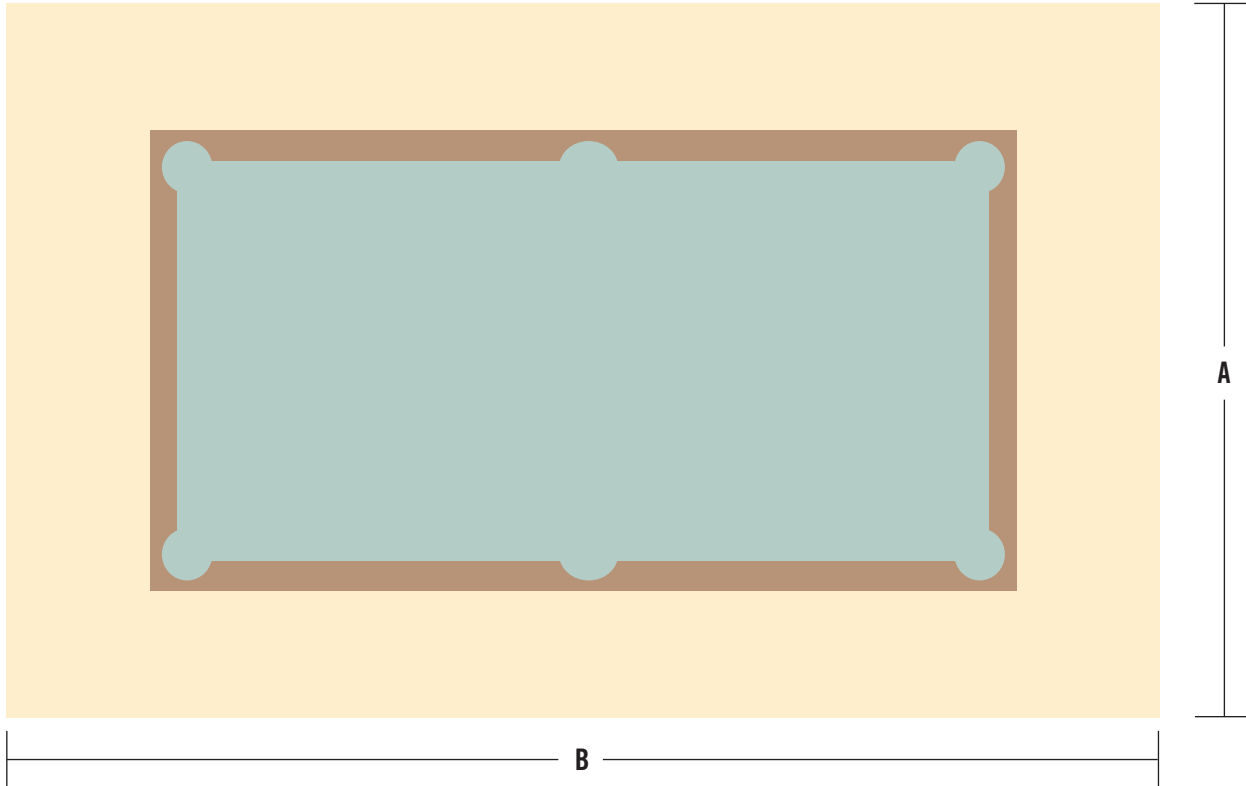

VISIT BRUNSWICKBILLIARDS.COM FOR GAME ROOM INSPIRATION.



BRUNSWICK LIFETIME WARRANTY

Every Brunswick table is a timeless tribute to excellence in design and workmanship. Proud to stand behind every product that carries the Brunswick name, Brunswick tables are guaranteed for a lifetime.

Please read all terms and conditions of the warranty. Brunswick reserves the right to change specifications without notice.

Different wood species offer unique texture and grain, as well as natural beauty. Minor variations in finish color may occur due to the natural characteristics of the wood. Photos may not be an accurate reflection of the product due to lighting conditions.



BRUNSWICK CERTIFIED SLATE

Demonstrating our enduring commitment to superior performance, Brunswick meets or exceeds all Billiard Congress of America slate specifications. Diamond honed and stringently tested, Brunswick slate is certified for quality and comes with a lifetime warranty.

SHUFFLEBOARD TABLES

Brunswick shuffleboard tables bring modern luxuries to classic gaming. Expert craftsmanship ensures our shuffleboards perform at the highest level and genuine designs give these boards an impeccable visual aesthetic.





PREMIER SHUFFLEBOARD

FEATURES

- Commercial environment durability
- Textured black painted metal with modern style with clean lines
- Four Climate adjusters
- Adjustable Leg Levelers
- Accessories include: four black weights, four red weights, built-in abacus scoring system, table brush, and shuffleboard wax

Table Size	12'
Dimensions (L x W x H)	145.9" x 28.4" x 32.1"
Weight	626 lbs*
Finish	Weathered Oak

* Shipping weight





SOHO SHUFFLEBOARD

FEATURES

- Natural grain and texture finish
- Modern style with clean lines
- Four climate adjusters
- Accessories include: four black weights, four red weights, built-in abacus scoring system, table brush, and shuffleboard wax



Table Size	12'
Dimensions (L x W x H)	146.9" x 28.7" x 32.1"
Weight	626 lbs*
Finish	Nutmeg

* Shipping weight



SANIBEL SHUFFLEBOARD

FEATURES

- Weathered finish showing natural grain and texture
- Modern style with clean lines
- Climate adjusters
- Accessories include: four black weights, four red weights, built-in abacus scoring system, table brush, and shuffleboard wax

Table Size	12' / 14'
Dimensions (L x W x H)	145.9" x 28.4" x 32.1" 169.9" x 28.4" x 32.1"
Weight	626 lbs* / 730 lbs*
Finish	Rustic Grey or Rustic Dark Brown

* Shipping weight



Rustic Dark Brown Finish



BOTANIC SHUFFLEBOARD

FEATURES

- Modern style with clean lines
- Four climate adjusters
- Accessories include: four black weights, four red weights, embedded abacus scoring system, board sweep and shuffleboard wax

Table Size	12'
Dimensions (L x W x H)	147.25" x 29.6" x 32.3"
Weight	535 lbs*
Finish	Dark Charcoal or Rustic Dark Brown

* Shipping weight





CANTON SHUFFLEBOARD

FEATURES

- Aged metal turn-buckle stretcher, corners, and hardware
- Hand-rubbed antique finish showcasing the natural grains and texture of the cabinet's rough-hewn wood
- Climate adjusters
- Accessories include: four black weights, four red weights, built-in abacus scoring system, table brush, and shuffleboard wax

Table Size	12' / 14'
Dimensions (L x W x H)	147.3" x 29.9" x 32.3" 171.5" x 29.9" x 32.3"
Weight	600 lbs* / 680 lbs*
Finish	Black Forest

* Shipping weight





INTRODUCING THE
NEW GOLD CROWN VII
SEE PAGE 8



THE GOLD STANDARD
A Legacy Since 1961

WWW.BRUNSWICKBILLIARDS.COM





CONCORD SHUFFLEBOARD

FEATURES

- Four climate adjusters
- Includes accessories: abacus set, four black weights, four red weights, board sweep, and shuffleboard wax
- Open shelves at each end of the table provide ample storage for included accessories
- Leg Levelers

Table Size	12'
Dimensions (L x W x H)	147.3" x 25.9" x 32.3"
Playfield	16" wide
Weight	597 lbs*
Finish	Nutmeg

* Shipping weight



ANDOVER II SHUFFLEBOARD

FEATURES

- Multiple climate adjusters (four on the 12' model, six on the 14' model)
- Includes accessories: abacus set, four black weights, four red weights, board sweep, and shuffleboard wax
- Four under cabinet open shelves at the center of the table provide ample storage for included accessories
- Leg Levelers

Table Size	12' / 14'
Dimensions (L x W x H)	147.3" x 29.9" x 32.3" 171.5" x 29.9" x 32.3"
Weight	531 lbs* / 596 lbs*
Finish Options	Rustic Dark Brown, Espresso, Driftwood (14' only)

* Shipping weight



Rustic Dark Brown Finish

DELRAY SHUFFLEBOARD

FEATURES

- Four climate adjusters
- Includes accessories: abacus set, four black weights, four red weights, board sweep, and shuffleboard wax
- Four under cabinet open shelves at the center of the table provide ample storage for included accessories
- Leg Levelers
- Optional scorer available (12' only)
- Optional light set (two lights) available

Table Size	9' / 12'
Dimensions (L x W x H)	110.3" x 24.63" x 32.3" 146.1" x 28.7" x 32.3"
Weight	550 lbs* / 546 lbs*
Finish	Black

* Shipping weight



SHUFFLEBOARD ROOM SIZE CHART

MINIMUM SPACE REQUIREMENTS

A recommendation of **thirty (30) inches** on each end (**A**) and **twelve (12) inches** on each side (**B**) of the table is given for comfortable playability.

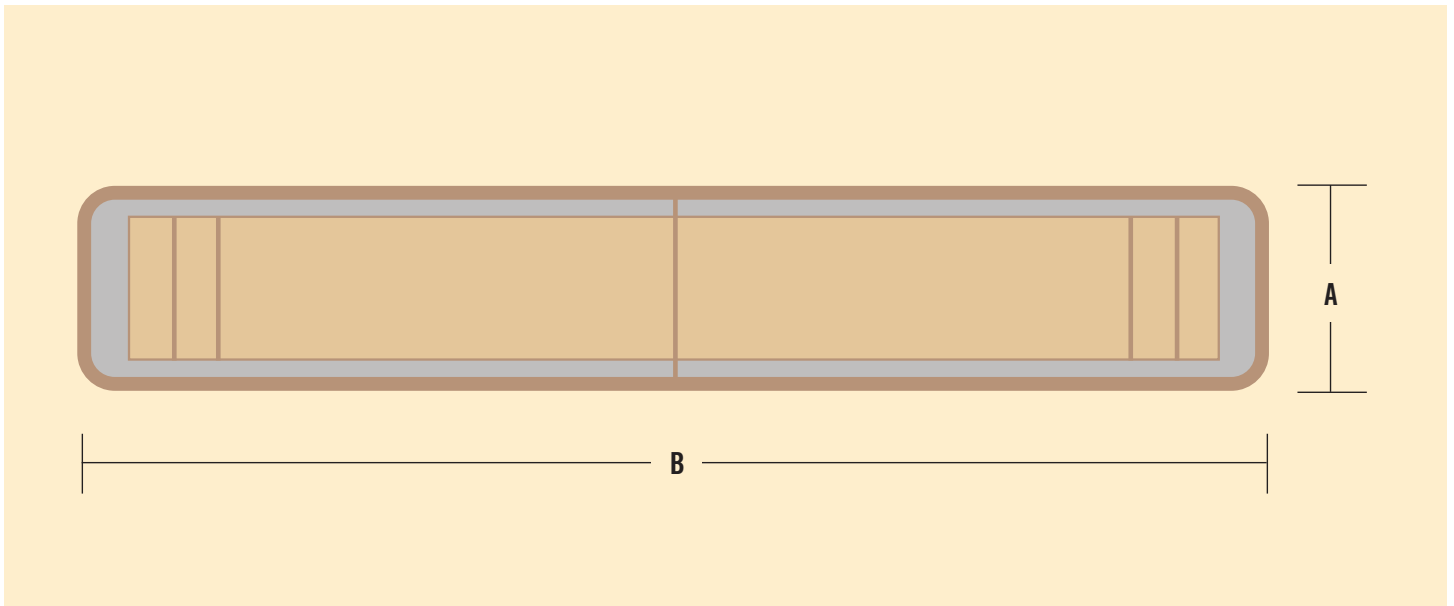

VISIT [BRUNSWICKBILLIARDS.COM](https://www.brunswickbilliards.com) FOR GAME ROOM INSPIRATION.



BRUNSWICK LIFETIME WARRANTY

Brunswick warrants its shuffleboard playfields against defects in materials and workmanship for the lifetime of the table. Brunswick warrants shuffleboard cabinets against defects in materials and workmanship for one (1) year from the date of purchase. This warranty is non-transferable and only applies to the initial purchaser (Owner) of the product purchased directly from Brunswick or an Authorized Brunswick Dealer.

Please read all terms and conditions of the warranty. Brunswick reserves the right to change specifications without notice.

Different wood species offer unique texture and grain, as well as natural beauty. Minor variations in finish color may occur due to the natural characteristics of the wood. Photos may not be an accurate reflection of the product due to lighting conditions.

SHUFFLEBOARD ACCESSORIES



16' SHUFFLEBOARD TABLE COVER

The Brunswick Shuffleboard Table Cover will fit the following Brunswick shuffleboard tables: 12' Andover 14' Andover 14' Brixton 12' Delray 14' Delray 12' Concord 12' Canton 14' Canton 12' Premier 14' Premier 12' Sanibel 14' Sanibel 12' Soho 14' Merrimack 16' Merrimack



SHUFFLEBOARD LIGHT SET

Easy to install table lights keep the play surface illuminated no matter where you place your shuffleboard table. Sturdy steel construction with black finish will complement any surroundings. Set of two fits the Andover, Delray, Brixton and Merrimack shuffleboard tables.



SHUFFLEBOARD BOWLING PINS

Turn one classic game into two with Brunswick's Shuffleboard Pins. Crafted out of solid wood, this miniature bowling set includes a wooden rack for easy set-up and 10 matching pins — adding a whole new level of competition to your shuffleboard table.



SHUFFLEBOARD WAX

Designed to help maintain optimum playability, Brunswick's shuffleboard wax allows you to have perfect control of your game.



SHUFFLEBOARD WEIGHT SET

Made from heat-treated hardened steel, Brunswick Billiard chrome-plated shuffleboard weights meet TSA tournament specifications. Includes four red and four black weights.

TABLE TENNIS

Brunswick Billiards gives table tennis a treatment of modern finesse. Enjoy a premium experience — whether just starting off or an expert in training.

BRUNSWICK®

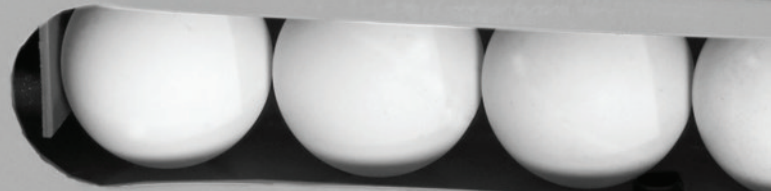

SMASH 7.0 TABLE TENNIS

FEATURES

- Black playing surface with repeat roller coating
- Material: 25mm thick MDF
- Frame: 20mm x 60mm heavy gauge steel tubing with silver powder coating
- Carriage: 40mm x 40mm heavy gauge steel tubing with silver powder coating
- Caster diameter: 100mm
- Premium net, post clamps and a ball & paddle set included
- Folds up for storage

Dimensions (L x W x H)	108" x 60" x 30" 36" x 60" x 63" (folded)
Weight	265 lbs*
Finish Options	Black

* Shipping weight



SMASH 7.0 I/O TABLE TENNIS

FEATURES

- Designed for indoor or outdoor play
- Black playing surface with repeat roller coating
- Material: 4mm aluminum clad ABS
- Frame: 20mm x 60mm heavy gauge steel tubing with silver powder coating
- Carriage: 50mm x 50mm heavy gauge steel tubing with silver powder coating
- Caster diameter: 125mm
- Premium net, post clamps and a ball & paddle set included
- Folds up and rolls away for storage

Dimensions (L x W x H)	108" x 60" x 30" 36" x 60" x 63" (folded)
Weight	176 lbs*
Finish	Black

* Shipping weight



SMASH 5.0 TABLE TENNIS

FEATURES

- Blue playing surface with repeat roller coating
- Material: 18mm thick MDF
- Frame: 20mm x 50mm heavy gauge steel tubing with silver powder coating
- Carriage: 35mm x 35mm heavy gauge steel tubing with silver powder coating
- Caster diameter: 75mm
- Premium net, post clamps, and ball & paddle set included
- Folds up for storage

Dimensions	108" x 60" x 30"
(L x W x H)	36" x 60" x 63" (folded)

Weight	220 lbs*
--------	----------

Finish	Blue
--------	------

* Shipping weight



SMASH 3.0 TABLE TENNIS

FEATURES

- Green playing surface with repeat roller coating
- Material: 16mm thick MDF
- Frame: 20mm x 40mm heavy gauge steel tubing with silver powder coating
- Carriage: 30mm x 30mm heavy gauge steel tubing with silver powder coating
- Caster diameter: 50mm
- Premium net, post clamps, and ball & paddle set included
- Folds up for storage

Dimensions	108" x 60" x 30"
(L x W x H)	36" x 60" x 63" (folded)

Weight	176 lbs*
--------	----------

Finish	Green
--------	-------

* Shipping weight



TABLE TENNIS ACCESSORIES



TABLE TENNIS PADDLE AND BALL SETS

Be ready to play anytime with performance-quality rackets and Brunswick balls with high control characteristics for consistent play and precision. Choose from a two- or four-player pack.



TABLE TENNIS PADDLE AND BALL SETS

Protect your Brunswick table tennis table from dust, spills, and other damage. The Brunswick Table Tennis Cover will fit the following Brunswick Smash tables: Smash 3.0 Smash 5.0 Smash 7.0.



TABLE TENNIS PREMIUM NET & POST

Our premium tournament-grade net and post system features high performance steel post and clips. The assembly is a simple snap and the net has easy adjustments. The premium cotton blend net measures 69.25".

TABLE TENNIS CONVERSION TOPS



CT8 TABLE TENNIS CONVERSION TOP

The friendly competition never ends with this durable, foam pad-backed table tennis conversion top. Includes everything you need to become the next neighborhood champ, including paddles, balls and clip-on net. Fits most eight-foot Brunswick billiard tables. This game top from Brunswick is manufactured to meet California's formaldehyde emissions regulations.



CT7 TABLE TENNIS CONVERSION TOP

Features a durable foam pad-backed top and measures 54" W x 92.3" L. Fits most seven-foot Brunswick billiard or air hockey tables and includes paddles, balls, and clip-on net. This game top from Brunswick is manufactured to meet California's formaldehyde emissions regulations.



TABLE TENNIS CONVERSION TOP CADDY

This space saving caddy is ideal for storing Brunswick table tennis conversion tops when not in use. Compact with a contemporary black finish and sturdy black caster wheels allowing for easy mobility. Compatible with both the Brunswick CT7 table tennis conversion top and the CT8 table tennis conversion top.

FOOSBALL TABLES

Get the whole family involved with our premium Brunswick Foosball tables. The quality craftsmanship of these tables allows you to control your game with precision and a variety of styles provide a great match for any space.





PREMIER FOOSBALL

FEATURES

- Three-man goalie for fast play
- Pre-assembled player rods with three-piece bearings
- End ball returns
- Black playfield with white graphics
- Includes eight balls, two additional players, two bearing sets and lubricant
- Adjustable levelers
- Standard dual abacus scorers

Dimensions (L x W x H)	57.6" x 55.4" x 36"
Weight	250 lbs*
Finish	Weathered Oak

* Shipping weight





STRIKER FOOSBALL

FEATURES

- Single-man goalie with sloped field corners
- Counterbalanced players, machine screw attached
- Wear resistance rod bearings, pre-assembled
- Green playfield with graphics
- Brunswick branded cabinet ends
- Standard dual abacus scorers
- Leg Levelers
- Includes two balls and two extra players

Dimensions (L x W x H) 55.1" x 54.9" x 36"

Weight 162 lbs*

Finish Weathered Oak

* Shipping weight





CORNER KICK FOOSBALL

FEATURES

- Single-man goalie with sloped field corners
- Counterbalanced players, machine screw attached
- Wear resistance rod bearings, pre-assembled
- Green playfield with graphics
- Includes two balls and two additional players
- Leg Levelers

Dimensions (L x W x H) 55.63" x 54.88" x 35.5"

Weight 141 lbs*

Finish Matte Black / Silver

* Shipping weight



AIR HOCKEY TABLES

Invented by Brunswick Billiards, air hockey offers hours of entertainment for all ages and ensures years of family fun.





PREMIER AIR HOCKEY

FEATURES

- Unique metal “X” frame base for increased stability
- Convertible game table covers allow for multi-functional use of the table
- Adjustable leg levelers
- Dual embedded abacus scorers
- Commercial grade play surface with unique graphics
- Commercial grade blower motor
- Accessories included: two white mallets** and four pucks (two red, two black)
- Compatible with CT7 Conversion Top



Table Size	7'
Dimensions (L x W x H)	87" x 47" x 31.25"
Weight	187 lbs*
Finish	Weathered Oak

* Shipping weight

** Table comes with two white mallets, black mallets used for reference only

V-FORCE AIR HOCKEY

FEATURES

- Exciting table top graphics and logo
- Constant flow UL blower motor
- Adjustable leg levelers
- Embedded abacus scoring
- Two black mallets and four pucks included
- Compatible with CT7 Conversion Top

Size	7'
Dimensions (L x W x H)	85.5" x 43.5" x 30"
Weight	172 lbs*
Finish	Bright Aluminum / Black

* Shipping weight



WINDCHILL II AIR HOCKEY

FEATURES

- Sleek, contemporary styling
- Dual embedded abacus scorers
- Sturdy pedestal base
- Constant flow UL blower
- Two black mallets and four pucks included
- Compatible with CT7 table tennis conversion top

Size	7'
Dimensions (L x W x H)	84.2" x 42.2" x 31.6"
Weight	165 lbs*
Finish	Black

* Shipping weight





THE ONLY GREEN

Brunswick Billiards brings you realistic putting greens designed to complement any setting.

HOW THE ONLY GREEN WORKS

BRUNSWICK'S, THE ONLY GREEN™, PUTTING GREENS OFFER THE MOST REALISTIC COURSE-LIKE CHALLENGES SUITED FOR ANY SPACE!

Our putting greens are designed to complement any setting, whether it's at your home, in the office, at a golf club, or apartment complex rec room; The Only Green putting greens maximize practice time in a minimum amount of space. Choose from The MacDonald, The Maxwell, or The Ross and find the perfect model for you based on your needs, whether it be competitive pricing, break stations, green elevation or the perfect size for your space.



Proprietary putting surface comes in a speed of 12.5 on the stimp meter. Green speed developed by PGA professionals and instructors predominantly recommending a true, tournament speed green.



A trouble-free mechanism housed within The Only Green enables players to set four different elevations of break into the green at each of the break stations. The ends of the green may also be elevated for uphill and downhill putts.



Elevations can be easily adjusted either by hand or from the standing position with any cavity back putter. Simply raise the knob in the vertical slot while sliding the other adjustment knob to the desired A through D break elevation, D being the highest elevation.

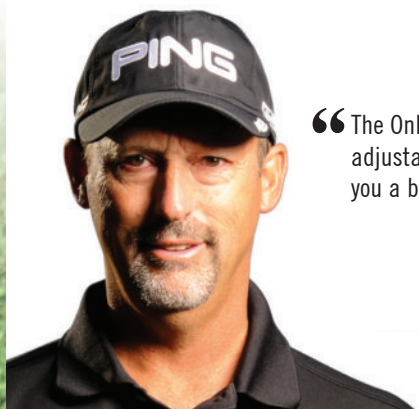

“The Only Green surface and adjustability will flat out make you a better putter.”
— Stan Utley,
PGA Instructor

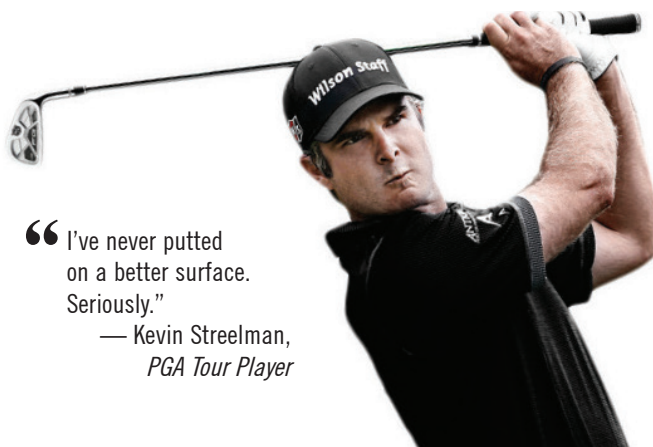

“I've never putted on a better surface. Seriously.”
— Kevin Streelman,
PGA Tour Player



**Putters not included.*

THE MACDONALD

FEATURES

- Six break stations, one on each side, for up to 50,000 break combinations
- Can be easily elevated on two ends to practice uphill and downhill putts
- Solid hardwoods and veneers material
- Green comes with one cup, one side step, and one headboard that also serves as a ball-stop

Size 4' wide x 12' long

Finish Options Espresso



ACCESSORIES

Matching putter rack that holds up to four putters, balls, and two drinks





**Putters not included.*

THE MAXWELL

FEATURES

- Four break stations for up to 1,000 break combinations
- Can be easily elevated on two ends to practice uphill and downhill putts
- Green comes in three 3' x 3' sections with one cup, one side step, and one headboard that also serves as a ball stop

Size 3' wide x 9' long

Finish Option Espresso



ACCESSORIES

Matching putter rack that holds up to four putters, balls, and two drinks





**Putters not included.*

THE ROSS

FEATURES

- Two break stations, one on each side, for up to 50 break combinations
- Can be easily elevated on two ends to practice uphill and downhill putts
- Green comes with one cup, one side step, and one headboard that also serves as a ball-stop

Size 2' wide x 8' long

Finish Options Espresso



ACCESSORIES

Matching putter rack that holds up to four putters, balls, and two drinks





GAME ROOM FURNITURE

Our superb selection of finely crafted furniture — tables, chairs, stools, and more — add both comfort and style to any room.

PARSONS GAME TABLE

PARSONS POKER TABLE

Expertly crafted of premium leather and hand-weathered oak, this game table is built to tournament standards. The tabletop, inset with leather, allows for smooth dealing while a wide wood rim provides a place to set a pint or cocktail. Poker set not included.

FEATURES

- Tabletop has an inset leather surface, traditional for playing card and dice games
- Seats up to 6
- Hand-weathered finish evokes the patina of reclaimed lumber
- Nicks, knots and imperfections are to be expected, and make each piece unique
- Table is 54" in diameter and is 31" tall



Inset leather surface, traditional for playing card and dice games



CENTENNIAL COLLECTION

The Centennial line is Brunswick's premium furniture collection. Made from beautiful solid hardwood, these items features gracefully arched legs accented with aged metal accents that provide a distinctively modern flair to any room. Choose from rich Espresso, Rustic Grey, Rustic Dark Brown and Black Wire Brush.

CENTENNIAL GAME TABLE

Like having two tables in one, the Centennial Game Table's top can be turned over to reveal a hardwood veneer dining surface. The gaming side features a luxurious yet spill-resistant playing surface.



Beautiful hardwood veneer dining surface, masterfully woven from alternating species of wood.



Deep beverage holders complete with Brunswick coasters and generous chip holders.



Convenient built-in compartment for all game accessories.



Rustic Grey



Espresso



Black Wire Brush



Rustic Dark Brown

CENTENNIAL COLLECTION



CENTENNIAL GAME CHAIRS

Settle in for a memorable night of fun and games in the uncompromising comfort of the distinctive new Centennial Game Chair. Featuring solid wood construction, this chair reclines, swivels, and adjusts in height to accommodate even the most animated of players. Choose either a rich Espresso, Rustic Grey, Rustic Dark Brown, Black Wire Brush, Mix and Match (Black Wire Brush and Rustic Grey only) and Natural dry oak finish



CENTENNIAL PUB TABLE

Take your seat around this inviting pub table for many enjoyable evenings with family and friends. With its signature arched legs and 42" height, the Centennial Pub Table provides timeless style and comfort. As beautiful as it is functional, the gracefully arched legs with their distinctive aged wrought iron ring base create a stylishly contemporary silhouette. Choose either a rich Espresso, Rustic Grey, Rustic Dark Brown, Black Wire Brush, and Mix and Match (Black Wire Brush and Rustic Grey only).



CLASSIC CENTENNIAL BAR STOOL

The traditionally-styled Classic Centennial Bar Stool is designed to match your favorite billiard table and furniture. Features include an easy-swivel seat, unique metal detail, and a comfortable 32" seat height. Choose either a rich Espresso, Rustic Grey, Rustic Dark Brown, Black Wire Brush, and Mix and Match (Black Wire Brush and Rustic Grey only). Sold as a set of two. A perfect complement to the Centennial Pub Table, Heritage Pub Table, or Brunswick Pub Table.



CENTENNIAL PLAYER'S CHAIR

A beautiful reproduction of a Brunswick chair from 1923. Designed to complement all billiard rooms, the player's chair adds class and elegance to any home. Features include comfortable pin-nailed seat cushion, hidden storage drawer, two cue notches and two cup holders in the armrests, and foot rest with black protector. Offered in Black Wire Brush, Espresso, Rustic Dark Brown and Rustic Grey



TRADITIONAL COLLECTION



TRADITIONAL PLAYER'S CHAIR

Take a seat while your opponent tries to run the table. Featuring a plush seat and back, a drink coaster built into one arm and cue holder in the other, the Traditional Player's Chair is the perfect place to wait your turn. You'll sit high enough to see all the action with its 26.5" seat height. Offered in a beautiful nutmeg, espresso, and rustic dark brown finish.



TRADITIONAL PUB TABLE

With timeless style and comfort, the Traditional Pub Table completes any game room setting. This table features a 30" round top with a smooth finish, a 42" height, an eclectic prism-shaped solid wood pedestal and base that features a built in USB port. Available in a rich nutmeg, espresso, and rustic dark brown finish.



TRADITIONAL BACKLESS PUB STOOLS

Constructed from solid wood with a cushioned seat that swivels, the Traditional Backless Pub Stools perfectly complement your favorite billiard table or other game room furnishings. You'll sit comfortably on the 30" high seat of man-made materials. Available in a rich nutmeg, espresso, and rustic dark brown finish.

BRUNSWICK ARENA FURNITURE



MIRROR WALL CUE RACK

- Commercial-Grade Construction: Engineered for high-traffic environments, minimizing replacement costs
- Signature Detailing: Features the recognizable Brunswick shield logo on the reflective mirror surface
- Customer Convenience: Integrated drink holders with coasters to help prevent spills and dedicated accessory storage for chalk
- Durable Finish: Matte black surface resists wear and maintains a professional appearances
- Capacity: Holds eight cues

ARENA PUB TABLE

- Commercial-Grade Construction: Metal base and wood top designed for consistent, heavy use
- Durable, Sealed Surface: Features the Brunswick shield logo, protected by a clear coat for long term durability
- Finish: Matte black surface provides a clean and modern aesthetic
- Holds up to eight cues, racks, and has multiple dowels and hooks for player accessories like purses, bags, and jackets



ARENA PLAYERS CHAIR

- Commercial-Grade Durability: Constructed for long-term use in high-traffic business environments, reducing maintenance
- Ergonomic Design: Bar height and oversized seat for maximum comfort
- Integrated Convenience: Single cue notch and two cup holders within armrests
- Footrest: Metal kick plate designed to withstand constant wear in commercial settings
- Signature Detailing: Matte black finish and embroidered Brunswick logo finishes designed for consistent, heavy-duty use in a busy pool room setting



FURNITURE COLLECTIONS

TRADITIONAL COLLECTION

CENTENNIAL COLLECTION

PARSONS

PUB TABLES



BAR STOOLS



PLAYER'S CHAIRS



GAME TABLES



GAME CHAIRS



FINISHES



BILLIARD CUE RACKS

We put the same level of detail and craftsmanship into all our products, including our line of cues, ball racks, pocket balls, and other accessories.



FLOOR & WALL CUE RACKS



HERITAGE FLOOR RACK

This freestanding floor rack is designed to hold up to eight cues, two ball racks, chalk, table brush, and additional accessories. Available in espresso, matte black, driftwood, rustic grey (shown), tuscana, coffee, natural hickory, nutmeg and rustic dark brown finishes.



HERITAGE WALL RACK

Round out your Heritage collection or accent your existing decor with this beautiful closed back transitional wall rack. The distinguished Louis-Philippe style angled header panel crowns storage for eight cues or seven cues and one bridge, 8-ball rack, 9-ball rack, set of billiard balls, brush, and chalk. Available in espresso, coffee, driftwood, matte black, nutmeg (shown) and rustic dark brown finishes.



BIRMINGHAM WALL RACK

A match to the Birmingham billiard table, the Birmingham wall rack features the same rustic Charcoal finish and industrial design elements. Includes a decorative iron plate with the Brunswick Billiard mark. Designed to hold eight cues or seven cues and the bridge stick. Available in charcoal finish.



CANTON WALL RACK

Rustic-meets-industrial charm with the Canton billiard table and matching wall cue rack. Designed to hold eight cues or seven cues and one bridge, the Canton wall rack is available in rustic grey finish only (shown).

WALL CUE RACKS



SANIBEL WALL RACK

A modern design with ultra clean lines and minimalist aesthetic, the Sanibel wall rack compliments the Sanibel billiard table. Designed to hold up to seven cues plus the bridge stick. Available in rustic gray finish and rustic dark brown.



DAMERON WALL RACK

A match to the Dameron billiard table, the Dameron wall rack features the same Nutmeg finish with metal trimmings. Designed to hold eight cues or seven cues and the bridge stick.

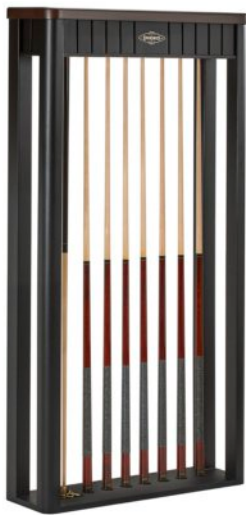

THE HENDERSON WALL RACK

A match to The Henderson billiard table, the Henderson wall rack comes in the following finishes: Espresso and Walnut/Aged Linen. Designed to hold eight cues or seven cues and the bridge stick.



SAGRADA WALL RACK

A match to the Sagrada billiard table, the Sagrada wall rack features the same Sandwashed finish. Designed to hold eight cues or seven cues and the bridge stick.

WALL CUE RACKS



PARSONS WALL RACK

A match to the Parsons billiard table, the Parsons wall rack features the same Natural Dry Oak Finish. Designed to hold eight cues or seven cues and the bridge stick.



COMMERCIAL WALL RACK

A match to the Gold Crown VI matte black, Black Wolf Pro and Black Wolf billiard tables, the Commercial Wall Rack features a matte black finish for a modern look. Designed with storage for up to eight cues.

DARTBOARD CABINETS



Rustic Grey Finish



Espresso Finish

TRADITIONAL DARTBOARD CABINETS

The Brunswick dartboard cabinet doors feature double chalk scoreboards, magnetic catches, chalk groove, and dart holders for storage. Features a cork backboard for steel-tip darts. Cabinet holds most steel- and soft-tip darts. Constructed of hardwood and hardwood veneers. Dartboard and darts not included.

Dimensions (L x W x D) 37" x 30.5" x 7.5"

Weight 53 lbs

Finish Options Black Wire Brush, Rustic Dark Brown, Rustic Grey and Espresso

BILLIARD CUES

BRUNSWICK CUE COLLECTION

Brunswick offers a range of cues for the billiard enthusiast. From the one-piece Tru-Balance cue to the top-quality Gold Crown Anniversary cues, you are sure to find a cue to fit your needs.



180TH ANNIVERSARY CUES
ONLY 60 PRODUCED
WORLDWIDE



GOLD CROWN ANNIVERSARY CUES IN COLLABORATION WITH LUCASI *NEW FOR 2025*

Celebrate 180 years of Brunswick Billiards with a cue that blends tradition and performance. This exclusive collaboration pairs a Brunswick cue butt with a Lucasi Zero Flexpoint shaft for precision and control. Available in three finishes, each in radial or Uniloc, and includes a custom case sleeve featuring the Brunswick 180th anniversary logo.



Brunswick Gold Crown Anniversary Cue I BGC701

Matte finish, Curly maple forearm, Snakewood, Silver and Pearl inlays, Cocobolo wrapless handle. Includes Lucasi Zero Flexpoint Shaft.



Brunswick Gold Crown Anniversary Cue I BGC702

Matte white painted forearm, Snakewood, Silver and Pearl inlays, Snake leather embossed wrap. Includes Lucasi Zero Flexpoint Shaft.



Brunswick Gold Crown Anniversary Cue I BGC703

Matte ebony painted forearm, Snakewood, Silver and Pearl inlays, Genuine leather wrap. Includes Lucasi Zero Flexpoint Shaft.

BILLIARD CUES



Contender Cue - Matte Black



Contender Cue - Matte Green



Brunswick Green Cue



Brunswick Brown Cue



Brunswick Cue



Centennial Cue



Heritage Cue

TWO-PIECE BRIDGE STICK

Two piece bridge stick. Solid brass bridgehead sold separately.



TWO-PIECE 48" CUE

This 48" cue is perfect for shots in tight corners or for those times you need the control and balance of a short cue.



BRUNSWICK JUNIOR CUE

Help young beginners have fun and gain confidence while they learn the game. This unique, one-piece, 38" junior cue features an attached cue ball, so even first-timers can succeed. Perfectly scaled and built with the same high quality materials and craftsmanship as our standard cues.



BILLIARD ACCESSORIES

At Brunswick, we put the same level of detail and craftsmanship into all our products including our line of cues, ball racks, pocket balls and other accessories. You will find everything you need to play a great game of pool and keep your Brunswick table in good shape.



PLAY PACKAGES

CENTENNIAL™ PLAY PACKAGE

Featuring our premium billiard accessories, this set includes everything you need to play the game. Contents include:

- Centennial® pocket balls
- Four Centennial® cues
- Two-piece short cue
- Two-piece bridge stick
- Brass bridge head
- Big Break® rack
- Nine-ball rack
- Table brush



HERITAGE™ PLAY PACKAGE

The Heritage package includes:

- Heritage® pocket balls
- Four Heritage® cues
- Two-piece short cue
- Two-piece bridge stick
- Brass bridge head
- Big Break® rack
- Nine-ball rack
- Table brush



BRUNSWICK PLAY PACKAGE

The Brunswick package includes:

- Set of standard billiard balls
- Four 58" Contender® two-piece cues
- Two-piece bridge stick
- Plastic bridge head
- 8-ball rack
- Plastic table brush
- Twelve pieces of chalk



BILLIARD BALLS



CENTENNIAL POCKET BALLS PREMIUM EDITION

Ground and polished for absolutely true and accurate roll. Constructed of 100% phenolic resin for uniform density. Centennial balls are ground and polished to radial tolerances of 0.001 of an inch. These balls represent the standard of excellence in the Billiard industry.



HERITAGE POCKET BALLS

Heritage pocket balls are designed for daily use. Made with high quality phenolic resin, Heritage balls are ground and polished to radial tolerances of 0.003 of an inch, for accurate, reliable performance.



TRADITIONAL POCKET BALLS

Traditional pocket balls are designed for regular use. Made with polyester, Traditional balls are ground and polished to radial tolerances of 0.003 of an inch, for accurate, reliable performance.

BILLIARD DINING TOPS

A practical addition to a Brunswick Billiards 7' or 8' table, these dining tops convert your 7' or 8' billiards table into a dining table, conference table or an arts & crafts room. The dining top comes in three pieces and is available in five colors for the 8' option and two colors in the 7' option. (Note: Dining tops will not fit all Brunswick Billiards table models.)



Shown in Nutmeg on the 8ft Soho billiard table

FEATURES

- Easy conversion from a billiard table into a dining, or other use, table
- Available in six finishes for 8' tables
- Available in three finishes for 7' tables

Dining Top Size	7' / 8'
Dimensions (L x W x H) per section, with Superspeed cushion rubber	7': 52.1" x 30.1" x 2.7" (132.3 x 76.5 x 6.9 cm) 8': 58.1" x 34.1" x 2.7" (147.6 x 86.6 x 6.9 cm)
Dimensions (L x W x H) per section, with Brunswick cushion rubber	7': 52.1" x 30.1" x 2.7" (132.3 x 76.5 x 6.9 cm) 8': 58.1" x 34.1" x 2.7" (147.6 x 86.6 x 6.9 cm)
Weight	7': 110 lbs* (49.9 kgs) 8': 165 lbs* (74.8 kgs)

Finish	Black Forest (8' only) Espresso (7' & 8') Matte Black (8' only) Nutmeg (8' only) Rustic Dark Brown (8' only) Tuscana (7' only)
--------	---

FINISH OPTIONS



BLACK FOREST
8ft Only



ESPRESSO
7ft & 8ft



MATTE BLACK
8ft Only



NUTMEG
8ft Only



RUSTIC DARK BROWN
8ft Only



TUSCANA
7ft Only

BILLIARD TABLE COVERS

Man-made leather, available in black or brown, with a 34" wide embossed Brunswick logo. Available in Standard to fit standard seven-, eight-, and nine-foot size billiard tables; Square Corner to fit square corner eight- and nine-foot size enclosed pocket billiard tables; and V-Corner to fit commercial design billiard tables. Custom sizes available through special order.



BILLIARD ACCESSORIES



9-BALL RACK

The nine ball rack is constructed of UV coated solid maple, with reinforced corners and dowel peg joinery.



BIG BREAK® RACK

Constructed of UV coated solid maple, with reinforced corners and dowel peg joinery, the Big Break rack is engineered to give you a tight fit for those breaks that count.



BILLIARD CHALK 12 & 144-PIECE, BLUE & GREEN

While deep in color, this chalk is lightly pigmented. It is manufactured from the finest velvet-grade silica, ensuring maximum adherence and friction qualities. Available in a 12 & 144-piece option.

BILLIARD ACCESSORIES

COLOR OPTIONS



BRUNSWICK BILLIARD CHALK 12 & 4-PIECE TUBE

Made from the finest quality sand mined only in the United States. Just the right amount of moisture and additives produce the highest quality billiard chalk to be found. Available in 12 colors, to match both our Centennial and Traditional cloth, in either a 4 piece or 12 piece option.



SOLID BRASS BRIDGEHEAD

The heavy-duty forged brass bridge head has wide slots for better cue control, rubber footings for stability, and it self-screws onto the bridge cue.



NATURAL HAIR TABLE BRUSH

Features naturally resilient hair bristles that are gentle on your billiard cloth and designed to reach hard to get areas such as under your table cushions.



BLUE DIAMOND CUE TIPS

Brunswick Billiards Blue Diamond Cue Tips are made from specially selected and treated leather and are infused with chalk. This creates a firm compressed cue tip for superb performance and playability time and time again. Available in 9, 10, and 11mm sizes.

INTRODUCING THE NEW

GC VII



2025 | PRODUCT CATALOG

BRUNSWICKBILLIARDS.COM

©2025 Brunswick Billiards. All rights reserved.